

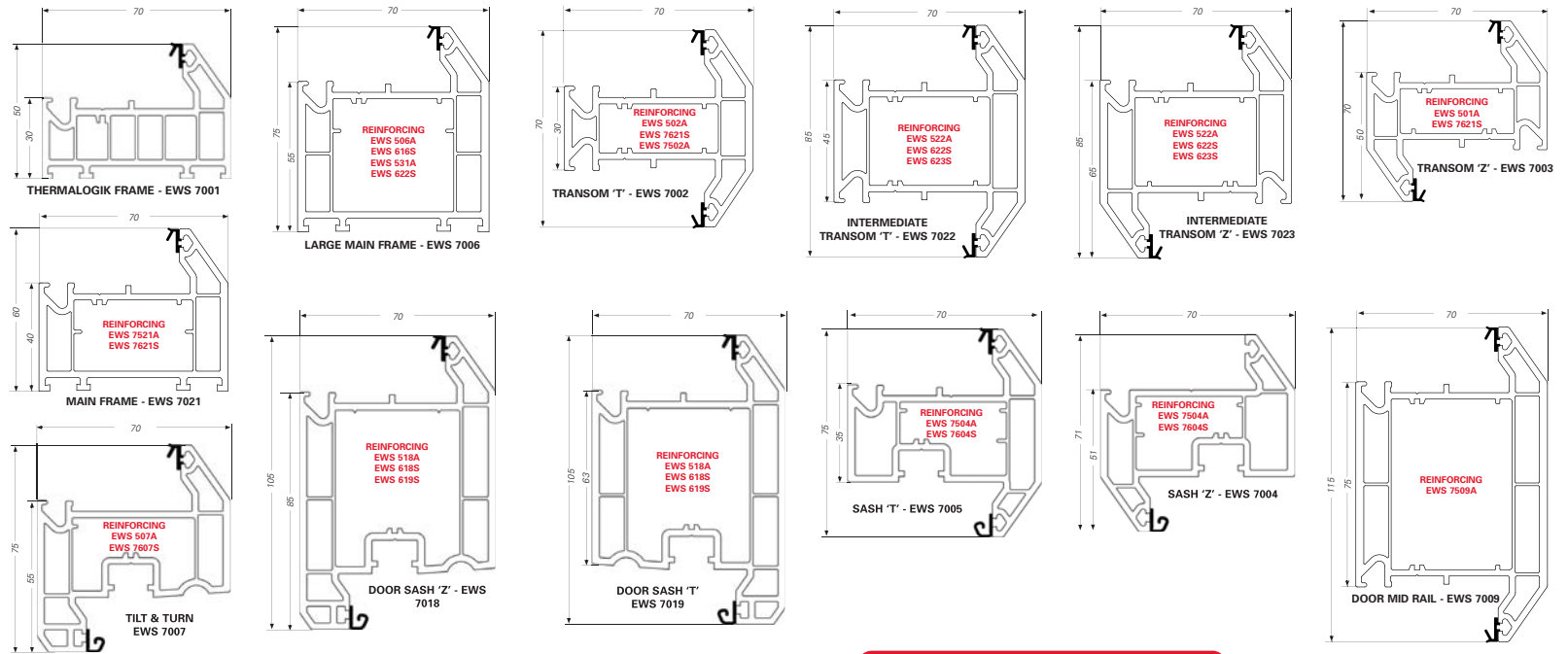

the **complete** solution

eurologik product chart
chamfered



cill sections & angles

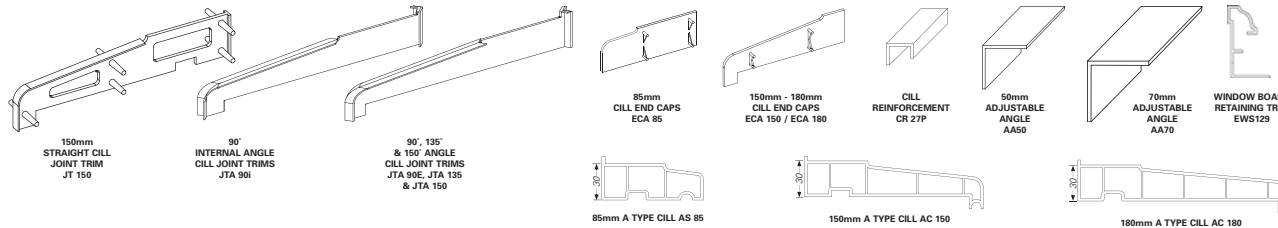

steel components

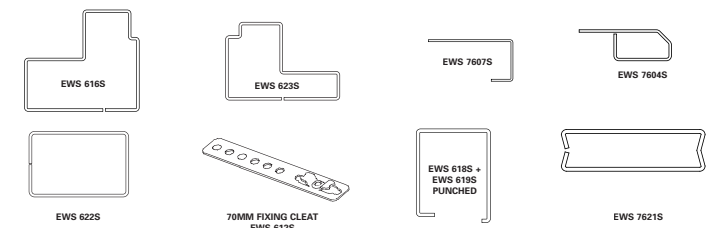

decorative features

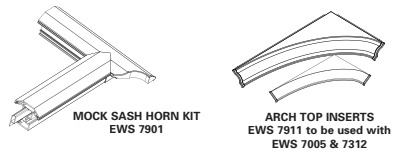

ancillaries, beads & gaskets

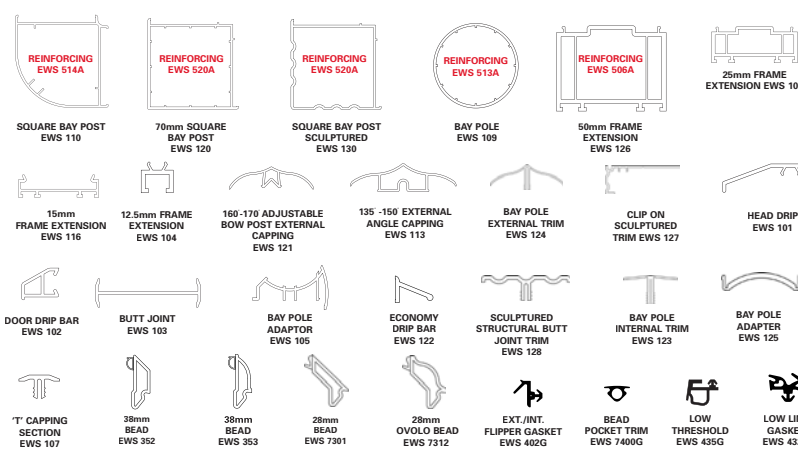

mouldings

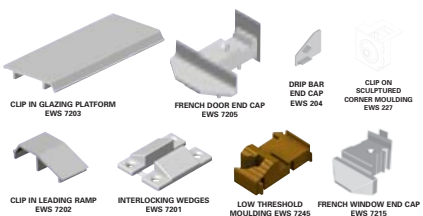

aluminium components

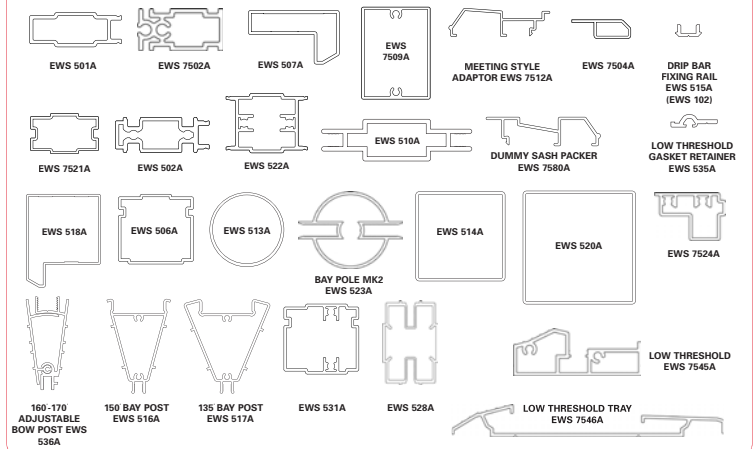



the **complete** solution

eurologik product chart
ovolo

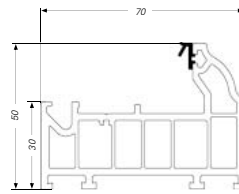

THERMALOGIK FRAME - EWS 7701

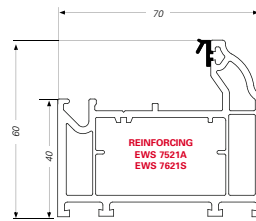

OVOLO MAIN FRAME - EWS 7721

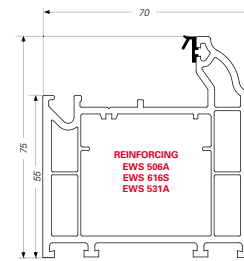

OVOLO LARGE MAIN FRAME - EWS 7706

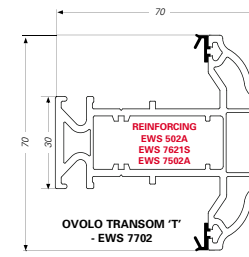

OVOLO TRANSOM 'T' - EWS 7702

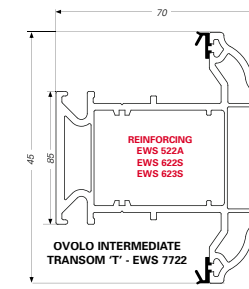

OVOLO INTERMEDIATE TRANSOM 'T' - EWS 7722

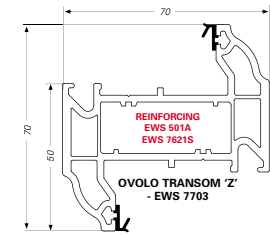

OVOLO TRANSOM 'Z' - EWS 7703

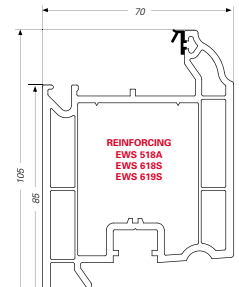

OVOLO DOOR SASH 'Z' - EWS 7718

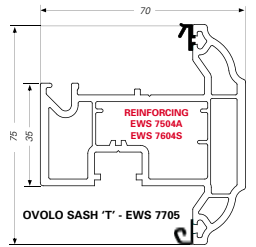

OVOLO SASH 'T' - EWS 7705

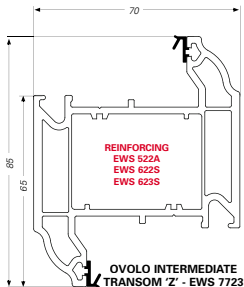

OVOLO INTERMEDIATE TRANSOM 'Z' - EWS 7723

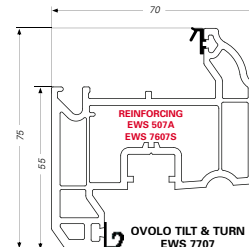

OVOLO TILT & TURN - EWS 7707

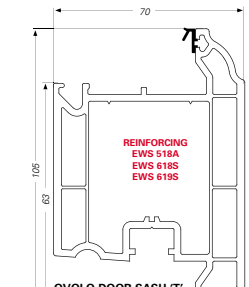

OVOLO DOOR SASH 'T' - EWS 7719

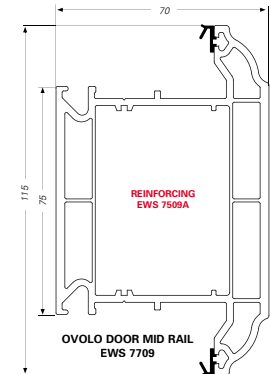

OVOLO DOOR MID RAIL - EWS 7709

cill sections & angles

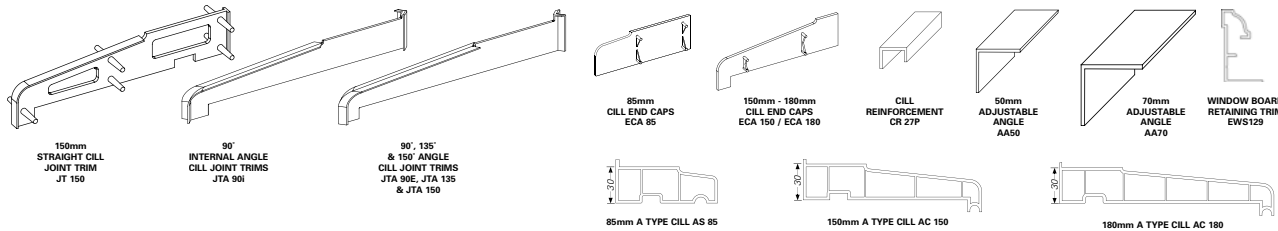

steel components

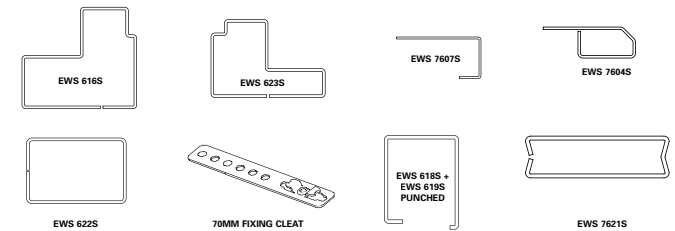

decorative features

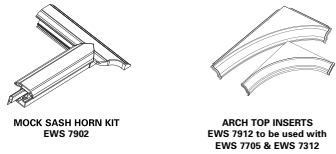

ancillaries, beads & gaskets

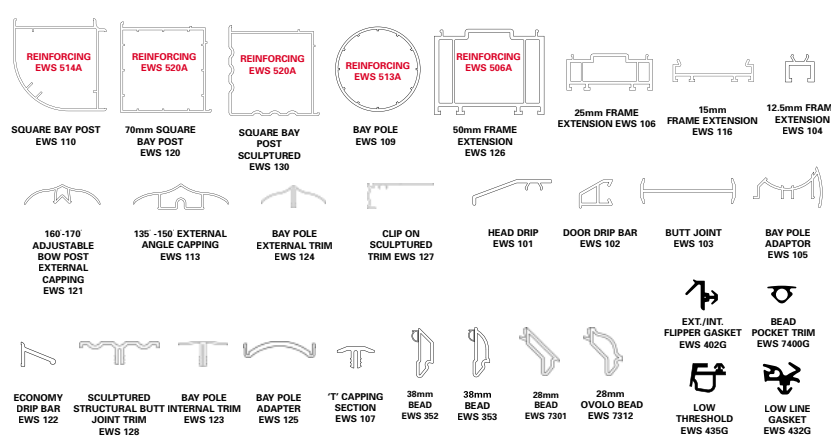

aluminium components

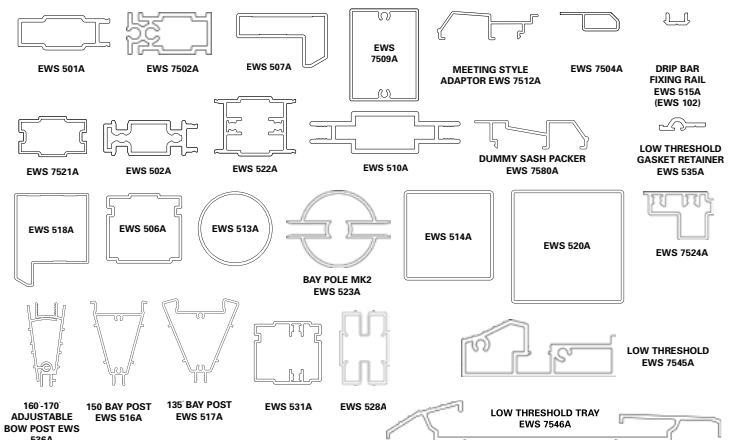

mouldings

